



## CONFIGURACIÓN ESTÁNDAR

- Chasis rígido
- Basculación máxima 45°
- Respaldo ángulo fijo a 90°
- Reposapiernas desmontable ángulo fijo a 75°
- Reposapiés divididos, abatibles, ajustables en altura, ángulo y profundidad
- Dispositivo antivuelco derecho + izquierdo
- Soporte para las piernas con cinturón acolchado
- Ruedas traseras negras neumáticas Ø400 mm
- Ruedas delanteras negras Ø150 PU
- 2 Asas de empuje regulables en altura

## MEDIDAS ANATÓMICAS

Altura total cm

Peso kg

1. Profundidad de asiento cm

2. Profundidad de pecho cm

3. Altura hasta axila cm

4. Altura hasta hombros cm

5. Altura hasta cabeza cm

6. Altura del codo a 90° cm

7. Altura de la pierna cm

8. Longitud codo + mano cm

9. Ancho de hombros cm

10. Ancho de pecho cm

11. Ancho de cadera cm

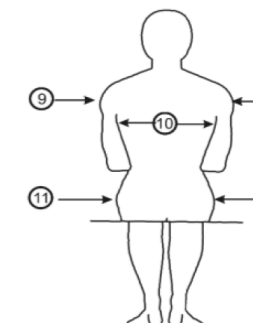
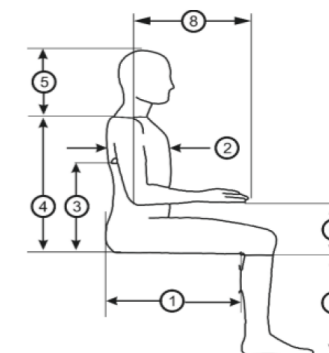

## INFORMACIÓN TÉCNICA

Peso máximo del usuario: **125 kg\***

\* Esta especificación puede cambiar según el ancho del asiento

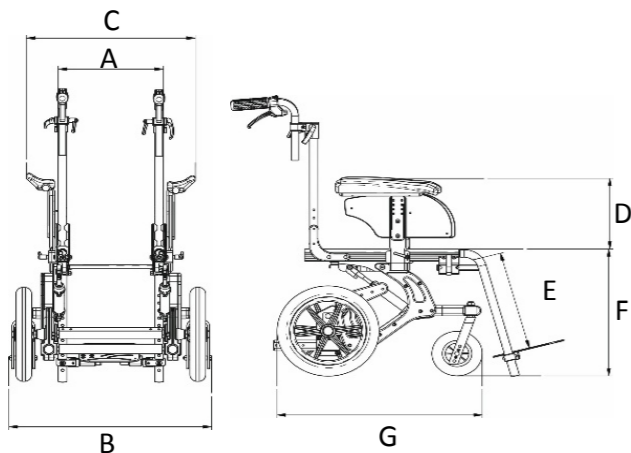
Peso de la silla de ruedas: máx. **30 kg**

Todas las medidas están en mm

A. Ancho de asiento	300	340	380	420	460
B. Ancho de las ruedas*	470	510	550	590	630
* con asiento freeshock esta medida aumenta 15 mm					
C. Ancho de los reposabrazos	410	450	490	530	570
D. Altura de los reposabrazos	180:270 o 270:360				
E. Longitud de reposapiernas	150:380				
F. Altura del asiento	470				
G. Largo	Ø300 mm: MIN 610 MÁX 720 Ø400 mm: MIN 665 MÁX 770				

## TAMAÑOS DEL CHASIS

Ancho de asiento Ajuste de profundidad

30 cm	30-36 cm*	S304-V087
	34-42 cm	S304-V085
	42-48 cm*	S304-V088
34 cm	34-42 cm	S304-V003
	42-50 cm	S304-V004
	38-46 cm	S304-V005
42 cm	46-54 cm	S304-V006
	42-50 cm	S304-V007
	50-54 cm	S304-V008
46 cm	54-60 cm*	S304-V089
	46-52 cm*	S304-V137
	52-58 cm*	S304-V138
	58-64 cm*	S304-V139

\*no compatible con asiento Free Shock

## CHASIS

Dyna - Chasis rígido

2.945 €

S304-V086

## RUEDAS

## RUEDAS TRASERAS

Tamaños de ruedas	Ø300 mm	SIN CARGO	S304-V009
	Ø400 mm	ESTÁNDAR	S304-V010
Tipo y color de ruedas	Ruedas negras PN neumáticas	ESTÁNDAR	S304-V011
	Ruedas negras PU rígidas	SIN CARGO	S304-V012
Freno de tambor		135,75 €	S304-V015

## RUEDAS DELANTERAS

Tipo, color y talla de ruedas	PU negras Ø150 mm	STANDARD	S304-V016
	PU negras Ø175 mm	SIN CARGO	S304-V082

## ASIENTO

## ASIENTO DE LONA

## Asiento de lona\*

\*no compatible con Free Sock o con base plana rígida desmontable

55,30 €

S304-V171

## Tiras de velcro

Loop (hembra)

9,85 €

S304-V172

Hook (macho)

9,85 €

S304-V173

## BASE PLANA RÍGIDA

## Base plana rígida desmontable\*

\*no compatible con asiento Free Shock  
o con asiento de lona (recomendado)

Tiras de velcro Loop (hembra)

142,50 €

S304-V099

Tiras de velcro Hook (macho)

142,50 €

S304-V185

## ASIENTO FREE SHOCK



## Asiento Free Shock

(incluye sistema de enganche asiento - respaldo)

\* requiere respaldo Free Shock

\*\* no compatible con asiento de lona o base plana rígida desmontable

858,75 €

S304-V102

## RESPALDO

## RESPALDO DE LONA

Respaldo de lona\*

\*no compatible con asiento Free Shock o con asiento de lona

67,55 €

S304-V186

## AJUSTES DEL RESPALDO

Respaldo fijo

90°

ESTÁNDAR

S304-V113

95°

SIN CARGO

S304-V114

100°

SIN CARGO

S304-V115

105°

SIN CARGO

S304-V116

110°

SIN CARGO

S304-V117

Respaldo reclinable con posiciones fijas (90° - 135°) - Pasos de 5°

180,60 €

S304-V118 (recomendado)

Respaldo reclinable con pistones (90° - 130°)

258,00 €

S304-V119



Respaldo activo Free Shock con pistón neumático (90° - 110°)

50 N

380,85 €

S304-V120

100 N

380,85 €

S304-V121

150 N

380,85 €

S304-V122

200 N

380,85 €

S304-V123

400 N

380,85 €

S304-V124



Respaldo activo Free Shock con pistón neumático (90° - 125°)

50 N

380,85 €

S304-V125

100 N

380,85 €

S304-V126

150 N

380,85 €

S304-V127

200 N

380,85 €

S304-V128

400 N

380,85 €

S304-V129

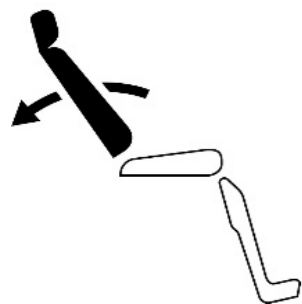

## ALTURA DE LOS TUBOS DEL RESPALDO

Altura de los  
tubos del  
respaldo

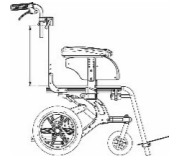

Altura de los tubos del respaldo: 45 cm

SIN CARGO

S304-V055

Altura de los tubos del respaldo: 50 cm

ESTÁNDAR

S304-V056

Altura de los tubos del respaldo: 55 cm

SIN CARGO

S304-V057

## ASAS DE EMPUJE



Barra de empuje estándar y empuñaduras separadas regulables en altura

ESTÁNDAR

S304-V146



Empuñaduras fijas

SIN CARGO

S304-V147



Empuñaduras articuladas

SIN CARGO

S304-V148

## REPOSACABEZAS



Reposacabezas Free Shock\*  
\*no compatible con respaldo de lona

Para elegir el hardware y la almohadilla del reposacabezas, consulte el formulario de pedido de Buddy Brace

## REPOSABRAZOS

## BARRA REPOSABRAZOS



Sin barra de reposabrazos

ESTÁNDAR

S304-V149

Barra reposabrazos baja  
(Ajuste de altura del reposabrazos 18-27 cm)

par

49,15 €

S304-V150

Barra reposabrazos alta  
(ajuste de altura del reposabrazos 27-36 cm)

par

49,15 €

S304-V151

## SOPORTE REPOSABRAZOS

Sin soportes

ESTÁNDAR

S304-V155



Soporte reposabrazos plano universal\*

\*compatible con reposabrazos Buddy Brace

\*\* barra de reposabrazos requerida

dcho.

SIN CARGO

S304-V187

izq.

SIN CARGO

S304-V188



Soporte reposabrazos inclinación regulable UD (inclinación)\*

\*compatible con reposabrazos Buddy Brace

\*\* barra de reposabrazos requerida

dcho.

73,70 €

S304-V189

izq.

73,70 €

S304-V190



Soporte reposabrazos rotación regulable LR (rotación)\*

\*compatible con reposabrazos Buddy Brace

\*\* barra de reposabrazos requerida

dcho.

73,70 €

S304-V191

izq.

73,70 €

S304-V192

Soporte reposabrazos COMBI\* regulable en inclinación  
y rotación

\*compatible con reposabrazos Buddy Brace

\*\* barra de reposabrazos requerida

dcho.

98,30 €

S304-V193

izq.

98,30 €

S304-V194

Para otras opciones, consultar Buddy Brace

## ALMOHADILLA DE REPOSABRAZOS

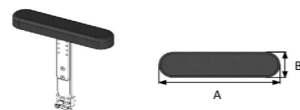

Almohadilla de polipiel\*  
\*requiere barra de reposabrazos  
y soporte de reposabrazos

A 30 cm - B 7 cm

par

73,70 €

S304-V195

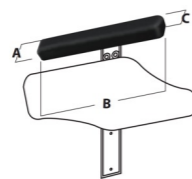

Almohadilla

Desplazable en anchura  
y profundidad

A 5 cm - B 25 cm - C 4 cm

dcho.

116,70 €

S202-V123

izq.

116,70 €

S202-V124

A 8 cm - B 30 cm - C 4 cm

dcho.

116,70 €

S202-V130

izq.

116,70 €

S202-V131

A 8 cm - B 40 cm - C 4 cm

dcho.

116,70 €

S202-V132

izq.

116,70 €

S202-V133

A 11 cm - B 35 cm - C 4 cm

dcho.

116,70 €

S202-V125

izq.

116,70 €

S202-V126

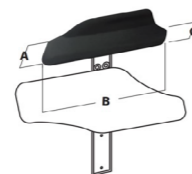
Almohadilla pared lateral  
externaDesplazable en anchura  
y profundidad

A 10 cm - B 32 cm - C 6 cm

dcho.

137,60 €

S202-V109

izq.

137,60 €

S202-V110

A 12 cm - B 42 cm - C 6 cm

dcho.

137,60 €

S202-V111

izq.

137,60 €

S202-V112

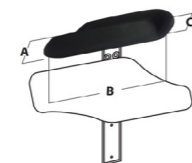
Almohadilla pared lateral  
interna/externaDesplazable en anchura  
y profundidad

A 10 cm - B 32 cm - C 6 cm

dcho.

137,60 €

S202-V113

izq.

137,60 €

S202-V114

A 12 cm - B 42 cm - C 6 cm

dcho.

137,60 €

S202-V115

izq.

137,60 €

S202-V116

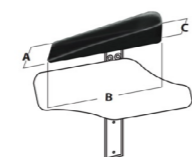
Almohadilla pared lateral  
interna/externa  
y posteriorDesplazable en anchura  
y profundidad

A 9 cm - B 35 cm - C 6 cm

dcho.

137,60 €

S202-V117

izq.

137,60 €

S202-V118

A 11,5 cm - B 40 cm - C 6 cm

dcho.

137,60 €

S202-V119

izq.

137,60 €

S202-V120

A 13 cm - B 45 cm - C 6 cm

dcho.

137,60 €

S202-V121

izq.

137,60 €

S202-V122

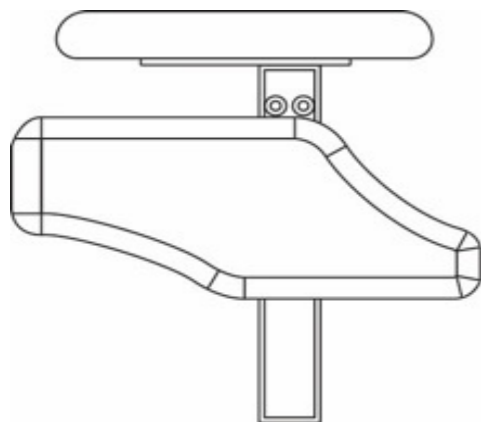



## PROTECTORES LATERALES

	Sin protectores		ESTÁNDAR	S304-V152
	Protectores PETG pequeñas 27x8 cm* *barra reposabrazos requerida		par	49,15 € S304-V153
	Protectores PETG 30x15 cm* *barra reposabrazos requerida		par	49,15 € S304-V154
	Apoyo lateral acolchado	A 8 cm - B 23 cm - C 2,5 cm	dcho.	79,85 € S213-V011
			izq.	79,85 € S213-V012
		A 11 cm - B 30 cm - C 3,5 cm	dcho.	79,85 € S213-V001
			izq.	79,85 € S213-V003
		A 13 cm - B 35 cm - C 3,5 cm	dcho.	79,85 € S213-V002
			izq.	79,85 € S213-V004
	Funda para soporte lateral PETG	Soporte lateral pequeño PETG 27 x 8 cm	par	73,70 € S213-V010
		Soporte lateral grande PETG 30 x 15 cm	par	73,70 € S213-V007

## REPOSAPIERNAS Y REPOSAPIÉS

## REPOSAPIERNAS

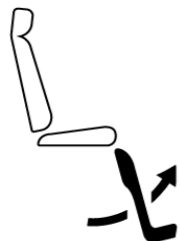

Ángulo fijo (75°) - extraíble

ESTÁNDAR

S304-V068

Ángulo fijo (75°) extraíble - abatible

86,00 €

S304-V145

Ángulo ajustable (90°-160°) extraíble

147,45 €

S304-V069

Reposapiernas extraíble Free Shock ajustable en ángulo (90°-170°)  
\*sólo compatible con reposapiés único - plataforma

282,55 €

S304-V071

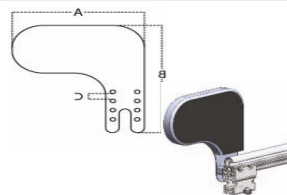
Soporte lateral de rodilla acolchado  
A 21 cm - B 26 cm - C 2 cm

dcho.

30,70 €

S210-V001

izq.

30,70 €

S210-V002

## Soporte de piernas pantorrillas

Cincha pantorrillas

ESTÁNDAR

S304-V135

Acolchado PU (individual)

130,20 €

S304-V075

## Reposapiés

Dividido - Individual

\*no compatible con reposapiernas Free Shock

ESTÁNDAR

S304-V072

Único\* - plataforma

\*no compatible con reposapiernas abatible

SIN CARGO

S304-V073



Único\* Free Shock

\*no compatible con reposapiernas abatible

176,90 €

S304-V077

## MESAS

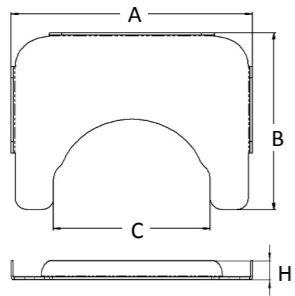

Mesa PETG\*  
(incluyendo sistema de fijación)  
\*no compatible con reposabrazos UD, LR  
y COMBI

Extra pequeña  
A 57 cm - B 47 cm - C 37 cm - H 4 cm

172,00 €

S304-V159

Pequeña  
A 67 cm - B 57 cm - C 47 cm - H 4 cm

172,00 €

S304-V160

Grande  
A 72 cm - B 57 cm - C 52 cm - H 4 cm

172,00 €

S304-V161

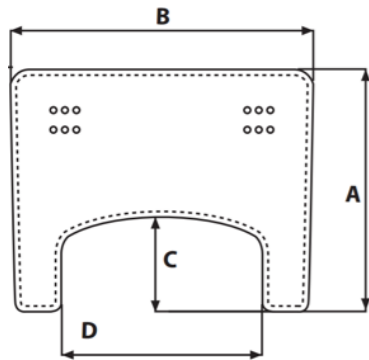

Mesa acolchada  
Incluye sistema de fijación

A 48 cm - B 60 cm  
C 19 cm - Pr 40 cm  
Distancia tubular de montaje:  
MIN 37,5 cm - MAX 49,0 cm

245,70 €

S204-V004

A 48 cm - B 65 cm  
C 19 cm - Pr 45 cm  
Distancia tubular de montaje:  
MIN 41,5 cm - MAX 53,0 cm

245,70 €

S204-V005

A 48 cm - B 70 cm  
C 19 cm - Pr 50 cm  
Distancia tubular de montaje:  
MIN 45,5 cm - MAX 57,0 cm

245,70 €

S204-V006

A 48 cm - B 80 cm  
C 19 cm - Pr 60 cm  
Distancia tubular de montaje:  
MIN 53.5 - MAX 65.0 cm

245,70 €

S204-V007

## OTROS ACCESORIOS



Fijación de 4 puntos para el transporte  
Crash test ISO 7176-19



294,85 €

S304-V162

## CAPOTA



Capota  
Compatible solo con ancho de asiento de 30 cm a 38 cm



Rosa

245,70 €

S207-V001

Lima

245,70 €

S207-V002

Azul claro

245,70 €















S207-V003

Negro

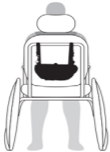
245,70 €

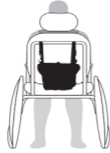
S207-V004

## BOLSAS

Bolsa			Ancho 24 cm Altura 12 cm	<input type="radio"/>	30,70 €	T005-V001
			Ancho 28 cm Altura 12 cm	<input type="radio"/>	30,70 €	T005-V002
Bolsa secreta			Ancho 22 cm Altura 18 cm	<input type="radio"/>	36,85 €	T005-V003
			Ancho 30 cm Altura 22 cm	<input type="radio"/>	36,85 €	T005-V004
Bolsa reforzada			Ancho 20 cm Altura 18 cm	<input type="radio"/>	43,00 €	T005-V005
			Ancho 30 cm Altura 22 cm	<input type="radio"/>	43,00 €	T005-V006
Bolsa suave impermeable			Ancho 22 cm Altura 12 cm	<input type="radio"/>	49,15 €	T005-V007
			Ancho 26 cm Altura 15 cm	<input type="radio"/>	49,15 €	T005-V008
Bolsa de cuero sintético			Ancho 30 cm Altura 20 cm	<input type="radio"/>	73,70 €	T005-V009
			Ancho 33 cm Altura 22 cm	<input type="radio"/>	73,70 €	T005-V010
Mochila			Ancho 30 cm Altura 29 cm	<input type="radio"/>	104,45 €	T005-V011
			Ancho 40 cm Altura 35 cm	<input type="radio"/>	104,45 €	T005-V012
Bolsa para respirador			Ancho 30 cm Altura 29 cm	<input type="radio"/>	122,85 €	T005-V013
			Ancho 40 cm Altura 35 cm	<input type="radio"/>	122,85 €	T005-V014

## COLORES

## COLOR 1 (área gris)

## COLOR 2 (área negra)



	Blanco [RAL 9016]	S304-VCC01
	Rojo metalizado [RAL 3002]	S304-VCC02
	Rojo brillante [RAL 3020]	S304-VCC03
	Magenta tele [RAL 4010]	S304-VCC18
	Rosa claro [RAL 3015]	S304-VCC05
	Naranja [RAL 2004]	S304-VCC06
	Amarillo [RAL 1018]	S304-VCC07
	Verde brillante	S304-VCC19
	Azul celeste [RAL 5015]	S304-VCC20
	Azul marino [RAL 5002]	S304-VCC11
	Lila [RAL 4005]	S304-VCC12
	Violeta [RAL 4008]	S304-VCC13
	Aluminio brillante [RAL 9006]	S304-VCC14
	Gris tráfico brillante [RAL 7043]	S304-VCC17
	Negro mate [RAL 9005]	S304-VCC15
	Charol negro [RAL 9005]	S304-VCC16





	Negro mate [RAL 9005]
---	-----------------------

## PERSONALIZACIONES

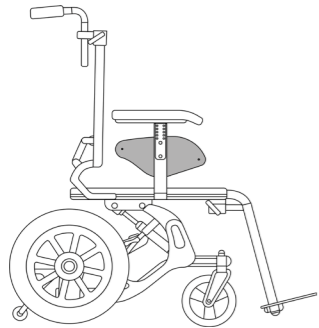
## STICKERS PARA PROTECTOR LATERAL

Diseños a elegir para personalizar la zona de la silla marcada en gris.

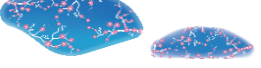

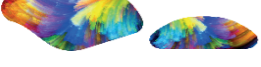







	Autos	par	61,45 €	S304-V163
	Infantil	par	61,45 €	S304-V164
	Tattoo	par	61,45 €	S304-V165
	Flores	par	61,45 €	S304-V166
	City	par	61,45 €	S304-V167
	Cashmere	par	61,45 €	S304-V168
	Sport	par	61,45 €	S304-V169
	Neutro	par	61,45 €	S304-V170

## STICKERS PARA MESA

Diseños a elegir para personalizar la zona marcada en gris.



	Autos	86,00 €	S304-V177
	Infantil	86,00 €	S304-V178
	Tattoo	86,00 €	S304-V179
	Flores	86,00 €	S304-V180
	City	86,00 €	S304-V181
	Cashmere	86,00 €	S304-V182
	Sport	86,00 €	S304-V183
	Neutro	86,00 €	S304-V184

OBSERVACIONES

---