



CONFIGURACIÓN ESTÁNDAR

- Chasis rígido / chasis plegable
- Basculación máxima 30°
- Respaldo ángulo fijo a 90°*
- Asas de empuje regulables en altura
- Reposapiernas desmontable ángulo fijo a 75°
- Reposapiés divididos, abatibles, ajustables en altura, ángulo y profundidad
- Cincha pantorrillas
- Ruedas traseras negras neumáticas Ø300 mm
- Ruedas delanteras negras Ø150 PU

* Asientos a medida, se recomienda S080-V208

MEDIDAS ANATÓMICAS

Altura total cm

Peso kg

1. Profundidad de asiento cm

2. Profundidad de pecho cm

3. Altura hasta axila cm

4. Altura hasta hombros cm

5. Altura hasta cabeza cm

6. Altura del codo a 90° cm

7. Altura de la pierna cm

8. Longitud codo + mano cm

9. Ancho de hombros cm

10. Ancho de pecho cm

11. Ancho de cadera cm

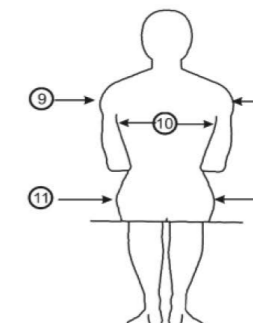
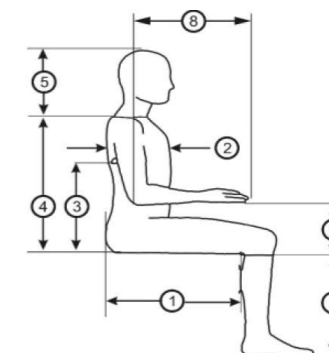

INFORMACIÓN TÉCNICA

Peso máximo del usuario: **150 kg***

* Esta especificación puede cambiar según el ancho del asiento

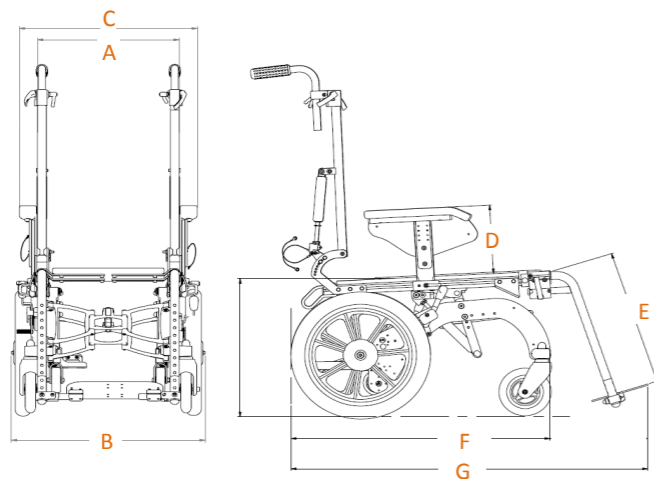
Peso de la silla de ruedas:
máx. **30 kg**

Todas las medidas están en mm

A. Ancho de asiento	260	280	300	340	380	420	440	460	480
B. Ancho de las ruedas (con ruedas Ø300)	476	476	496	496	536	576	596	616	636
C. Ancho de los reposabrazos	370	390	410	450	490	530	550	570	590
D. Altura de los reposabrazos	180:270 / 270:360								
E. Longitud de reposapiernas	150:400								
F. Largo	700:865								
G. Largo total	1100:1200								

TAMAÑOS DEL CHASIS

	Ancho de asiento	Ajuste de profundidad	
		26-32 cm	S080-V051
26 cm		32-38 cm	S080-V052
		38-42 cm	S080-V053
28 cm		28-34 cm	S080-V054
		34-40 cm	S080-V055
		40-46 cm	S080-V056
30 cm		30-36 cm	S080-V057
		36-42 cm	S080-V058
		42-48 cm	S080-V059
34 cm		34-40 cm	S080-V060
		40-46 cm	S080-V061
		46-52 cm	S080-V062
38 cm		38-44 cm	S080-V063
		44-50 cm	S080-V064
		50-56 cm	S080-V065
42 cm		42-48 cm	S080-V066
		48-54 cm	S080-V067
		54-60 cm	S080-V068
44 cm		44-50 cm	S080-V069
		50-56 cm	S080-V070
		56-62 cm	S080-V071
46 cm		46-52 cm	S080-V609
		52-58 cm	S080-V610
		58-64 cm	S080-V611
48 cm*		48-54 cm	S080-V072
		54-60 cm	S080-V073
		60-66 cm	S080-V074

CHASIS

LB - Chasis rígido	2.050 €	S080-V001
LB - Chasis plegable	2.235 €	S080-V002

*no compatible con ancho de asiento 48 cm

RUEDAS

RUEDAS TRASERAS

Tamaños de ruedas	Ø300 mm	ESTÁNDAR	S080-V102
	Ø400 mm	SIN CARGO	S080-V115
	Ø20"	SIN CARGO	S080-V103
	Ø22"	SIN CARGO	S080-V104
	Ø24"	SIN CARGO	S080-V105
Tipo y color de ruedas	Ruedas negras PN neumáticas	ESTÁNDAR	S080-V106
	Ruedas negras PU rígidas	SIN CARGO	S080-V107
Freno de tambor	<input type="radio"/>	135,75 €	S080-V108
Protectores de radios (no compatibles con ruedas de Ø300 mm y Ø400 mm)	<input type="radio"/>	53,45 €	S080-V109
Aros (no compatible con ruedas de Ø300 mm y Ø400 mm)	<input type="radio"/>	66,35 €	S080-V110

RUEDAS DELANTERAS

Tipo, color y talla de ruedas	PU negras Ø125 mm	SIN CARGO	S080-V614
	PU negras Ø150 mm	ESTÁNDAR	S080-V615
	PU negras Ø175 mm	SIN CARGO	S080-V618

ASIENTO

ASIENTO DE LONA

Asiento de lona*

*no compatible con base plana rígida desmontable



55,30 €

S080-V635

Tiras de velcro

Loop (hembra)



9,85 €

S080-V636

Hook (macho)



9,85 €

S080-V637

BASE PLANA RÍGIDA

Base plana rígida desmontable* / **

*no compatible con asiento de lona

(Recomendado)

**Imprescindible para el chasis plegable con asientos moldeados

Tiras de velcro Loop (hembra)



142,50 €

S080-V624

Tiras de velcro Hook (macho)



142,50 €

S080-V670

BASCULACIÓN



Mediante pedal*

*solo se puede colocar en el lado derecho de la silla de ruedas

ESTÁNDAR

S080-V627

Manetas en las empuñaduras

SIN CARGO

S080-V202

DISPOSICIÓN BASCULACIÓN

Basculación negativa a 10°*

*no compatible con ancho de asiento de 26 cm a 34 cm

SIN CARGO

S080-V201

Sin basculación negativa

ESTÁNDAR

S080-V639

RESPALDO

RECLINACIÓN DEL RESPALDO

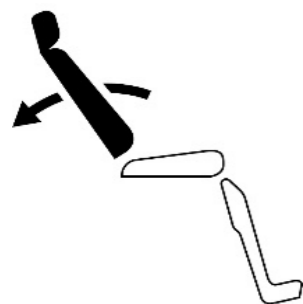

Respaldo fijo	90°	ESTÁNDAR	S080-V203
	95°	SIN CARGO	S080-V204
	100°	SIN CARGO	S080-V205
	105°	SIN CARGO	S080-V206
	110°	SIN CARGO	S080-V207
Respaldo reclinable con posiciones fijas (90° - 135°) - Pasos de 5°		180,60 €	S080-V208 *Recomendado
Respaldo reclinable con pistones (90° - 130°)		258,00 €	S080-V209
Respaldo activo con pistón neumático (90° - 110°)	50 N	380,85 €	S080-V628
	100 N	380,85 €	S080-V629
	150 N	380,85 €	S080-V630
	200 N	380,85 €	S080-V631
	400 N	380,85 €	S080-V632
Respaldo activo con pistón neumático (90° - 125°)	50 N	380,85 €	S080-V654
	100 N	380,85 €	S080-V655
	150 N	380,85 €	S080-V656
	200 N	380,85 €	S080-V657
	400 N	380,85 €	S080-V658

ALTURA DE LOS TUBOS DEL RESPALDO



Altura de los tubos del respaldo: 45 cm

SIN CARGO

S080-V377

Altura de los tubos del respaldo: 50 cm

ESTÁNDAR

S080-V378

Altura de los tubos del respaldo: 55 cm

SIN CARGO

S080-V379

ASAS DE EMPUJE



Barra de empuje estándar y empuñaduras separadas regulables en altura

ESTÁNDAR

S080-V380

Empuñaduras fijas*
*no compatible con chasis plegable

SIN CARGO

S080-V381

Empuñaduras articuladas*
*no compatible con chasis plegable

SIN CARGO

S080-V382

RESPALDO DE LONA

Respaldo de lona



67,55 €

S080-V383

REPOSABRAZOS

BARRA REPOSABRAZOS



Sin barra de reposabrazos

ESTÁNDAR

S080-V640

Barra reposabrazos baja
(Ajuste de altura del reposabrazos 18-27 cm)

par

49,15 €

S080-V633

Barra reposabrazos alta
(ajuste de altura del reposabrazos 27-36 cm)

par

49,15 €

S080-V402

SOPORTE REPOSABRAZOS

Sin soportes

ESTÁNDAR

S080-V407



Soporte reposabrazos plano universal*

*compatible con reposabrazos Buddy Brace

** barra de reposabrazos requerida

dcho.

SIN CARGO

S080-V659

izq.

SIN CARGO

S080-V660



Soporte reposabrazos inclinación regulable UD (inclinación)*

*compatible con reposabrazos Buddy Brace

** barra de reposabrazos requerida

dcho.

73,70 €

S080-V661

izq.

73,70 €

S080-V671



Soporte reposabrazos rotación regulable LR (rotación)*

*compatible con reposabrazos Buddy Brace

** barra de reposabrazos requerida

dcho.

73,70 €

S080-V672

izq.

73,70 €

S080-V673

Soporte reposabrazos COMBI* regulable en inclinación
y rotación

*compatible con reposabrazos Buddy Brace

** barra de reposabrazos requerida

dcho.

98,30 €

S080-V674

izq.

98,30 €

S080-V675

Para otras opciones, consultar Buddy Brace

ALMOHADILLA DE REPOSABRAZOS

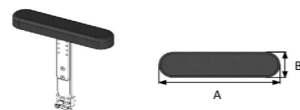

Almohadilla de polipiel*
*requiere barra de reposabrazos
y soporte de reposabrazos

A 30 cm - B 7 cm

par

73,70 €

S080-V676

A 5 cm - B 25 cm - C 4 cm

dcho.

116,70 €

S202-V123

izq.

116,70 €

S202-V124

A 8 cm - B 30 cm - C 4 cm

dcho.

116,70 €

S202-V130

izq.

116,70 €

S202-V131

A 8 cm - B 40 cm - C 4 cm

dcho.

116,70 €

S202-V132

izq.

116,70 €

S202-V133

A 11 cm - B 35 cm - C 4 cm

dcho.

116,70 €

S202-V125

izq.

116,70 €

S202-V126

A 10 cm - B 32 cm - C 6 cm

dcho.

137,60 €

S202-V109

izq.

137,60 €

S202-V110

A 12 cm - B 42 cm - C 6 cm

dcho.

137,60 €

S202-V111

izq.

137,60 €

S202-V112

A 10 cm - B 32 cm - C 6 cm

dcho.

137,60 €

S202-V113

izq.

137,60 €

S202-V114

A 12 cm - B 42 cm - C 6 cm

dcho.

137,60 €

S202-V115

izq.

137,60 €

S202-V116

A 9 cm - B 35 cm - C 6 cm

dcho.

137,60 €

S202-V117

izq.

137,60 €

S202-V118

A 11,5 cm - B 40 cm - C 6 cm

dcho.

137,60 €

S202-V119

izq.

137,60 €

S202-V120

A 13 cm - B 45 cm - C 6 cm

dcho.

137,60 €

S202-V121

izq.

137,60 €



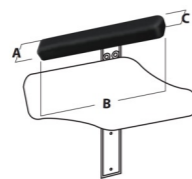
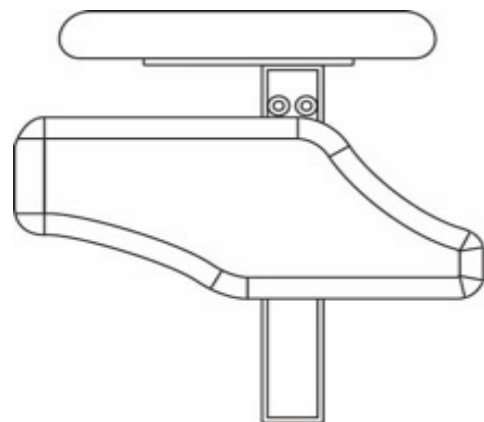

S202-V122

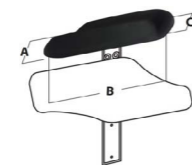
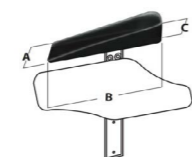

Almohadilla

Desplazable en anchura
y profundidadAlmohadilla pared lateral
externaDesplazable en anchura
y profundidadAlmohadilla pared lateral
interna/externaDesplazable en anchura
y profundidadAlmohadilla pared lateral
interna/externa
y posteriorDesplazable en anchura
y profundidad

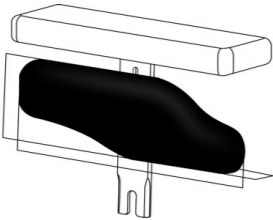
PROTECTORES LATERALES

	Sin protectores		<input type="radio"/>	ESTÁNDAR	S080-V405
	Protectores PETG pequeñas 27x8 cm* *barra reposabrazos requerida		<input type="radio"/>	49,15 €	S080-V634
	Protectores PETG 30x15 cm* *barra reposabrazos requerida		<input type="radio"/>	49,15 €	S080-V406
	Apoyo lateral acolchado	A 8 cm - B 23 cm - C 2,5 cm	<input type="radio"/>	79,85 €	S213-V011
			<input type="radio"/>	79,85 €	S213-V012
		A 11 cm - B 30 cm - C 3,5 cm	<input type="radio"/>	79,85 €	S213-V001
			<input type="radio"/>	79,85 €	S213-V003
		A 13 cm - B 35 cm - C 3,5 cm	<input type="radio"/>	79,85 €	S213-V002
			<input type="radio"/>	79,85 €	S213-V004
	Funda para soporte lateral PETG	Soporte lateral pequeño PETG 27 x 8 cm	<input type="radio"/>	73,70 €	S213-V010
		Soporte lateral grande PETG 30 x 15 cm	<input type="radio"/>	73,70 €	S213-V007

REPOSAPIERNAS Y REPOSAPIÉS

REPOSAPIERNAS

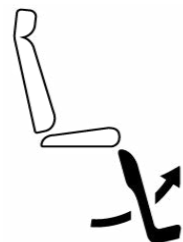

Ángulo fijo (75°) extraíble - abatible

86,00 €

S080-V642

Ángulo fijo (75°) - extraíble

ESTÁNDAR

S080-V211

Ángulo fijo (90°) abducción (4 cm por lado) extraíble

36,85 €

S080-V212

Ángulo ajustable (90°-170°) extraíble

147,45 €

S080-V213

Ángulo ajustable (90°-170°) desmontable activo con pistón neumático

282,55 €

S080-V214

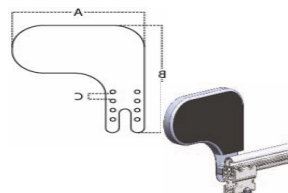
Soporte lateral de rodilla acolchado
A 21 cm - B 26 cm - C 2 cm

dcho.

30,70 €

S210-V001

izq.

30,70 €

S210-V002

Soporte de piernas pantorrillas

Cincha pantorrillas

ESTÁNDAR

S080-V453

Acolchado PU (individual)

103,20 €

S080-V454

Reposapiés

Dividido - Individual

ESTÁNDAR

S080-V451

Único* - plataforma

*no compatible con reposapiernas abatible

SIN CARGO

S080-V452

MESAS

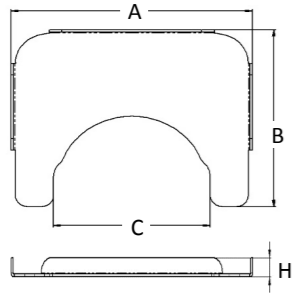

Mesa PETG*
(incluyendo sistema de fijación)
*no compatible con reposabrazos UD, LR
y COMBI

Extra pequeña
A 57 cm - B 47 cm - C 37 cm - H 4 cm



172,00 €

S080-V643

Pequeña
A 67 cm - B 57 cm - C 47 cm - H 4 cm



172,00 €

S080-V644

Grande
A 72 cm - B 57 cm - C 52 cm - H 4 cm



172,00 €

S080-V645

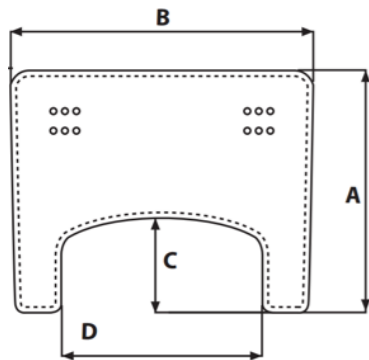

Mesa acolchada
Incluye sistema de fijación

A 48 cm - B 60 cm
C 19 cm - Pr 40 cm
Distancia tubular de montaje:
MIN 37,5 cm - MAX 49,0 cm



245,70 €

S204-V004

A 48 cm - B 65 cm
C 19 cm - Pr 45 cm
Distancia tubular de montaje:
MIN 41,5 cm - MAX 53,0 cm



245,70 €

S204-V005

A 48 cm - B 70 cm
C 19 cm - Pr 50 cm
Distancia tubular de montaje:
MIN 45,5 cm - MAX 57,0 cm



245,70 €

S204-V006

A 48 cm - B 80 cm
C 19 cm - Pr 60 cm
Distancia tubular de montaje:
MIN 53.5 - MAX 65.0 cm



245,70 €

S204-V007

OTROS ACCESORIOS



Fijación de 4 puntos para el transporte
Crash test ISO 7176-19



294,85 €

S080-V502

Antivuelco con pisapié

dcho.

79,85 €

S080-V503

izq.

79,85 €

S080-V504

Ruedas de tránsito



SIN CARGO

S080-V5072

Compartimento para respirador*

*requiere chasis rígido

** compatible solo con ancho de asiento de 34 cm a 46 cm



430,00 €

S080-V508

CAPOTA



Capota
Compatible solo con ancho de asiento de 30 cm a 38 cm



Rosa



245,70 €

S207-V001

Lima



245,70 €

S207-V002

Azul claro



245,70 €

S207-V003















Negro



245,70 €

S207-V004

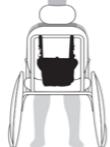
BOLSAS

Bolsa			Ancho 24 cm Altura 12 cm	<input type="radio"/>	30,70 €	T005-V001
			Ancho 28 cm Altura 12 cm	<input type="radio"/>	30,70 €	T005-V002
Bolsa secreta			Ancho 22 cm Altura 18 cm	<input type="radio"/>	36,85 €	T005-V003
			Ancho 30 cm Altura 22 cm	<input type="radio"/>	36,85 €	T005-V004
Bolsa reforzada			Ancho 20 cm Altura 18 cm	<input type="radio"/>	43,00 €	T005-V005
			Ancho 30 cm Altura 22 cm	<input type="radio"/>	43,00 €	T005-V006
Bolsa suave impermeable			Ancho 22 cm Altura 12 cm	<input type="radio"/>	49,15 €	T005-V007
			Ancho 26 cm Altura 15 cm	<input type="radio"/>	49,15 €	T005-V008
Bolsa de cuero sintético			Ancho 30 cm Altura 20 cm	<input type="radio"/>	73,70 €	T005-V009
			Ancho 33 cm Altura 22 cm	<input type="radio"/>	73,70 €	T005-V010
Mochila			Ancho 30 cm Altura 29 cm	<input type="radio"/>	104,45 €	T005-V011
			Ancho 40 cm Altura 35 cm	<input type="radio"/>	104,45 €	T005-V012
Bolsa para respirador			Ancho 30 cm Altura 29 cm	<input type="radio"/>	122,85 €	T005-V013
			Ancho 40 cm Altura 35 cm	<input type="radio"/>	122,85 €	T005-V014

COLORES

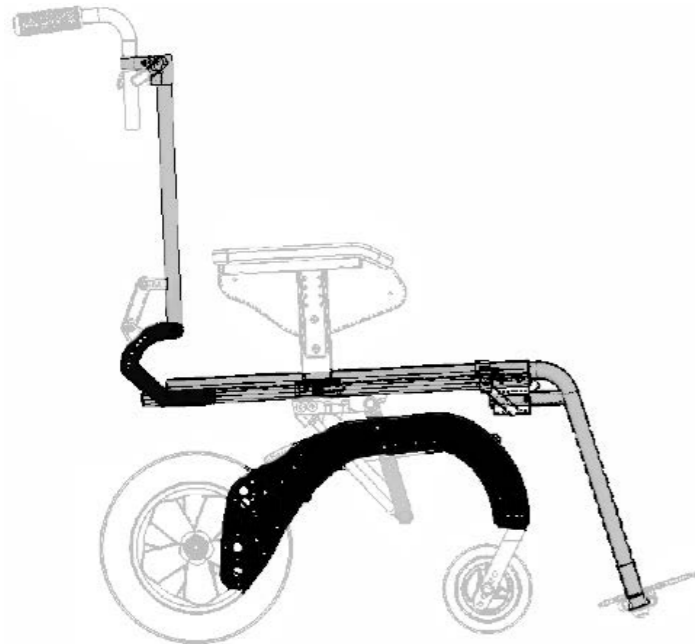

Con la opción "1 color" es posible elegir un solo color tanto para las zonas grises como para las negras, con la opción "2 colores" es posible elegir dos colores diferentes para las zonas grises y negras.

1 color	ESTÁNDAR	S080-V551
2 colores	46,70 €	S080-V552

COLOR 1 (área negra)

	Blanco [RAL 9016]	S080-VCC01
	Rojo metalizado [RAL 3002]	S080-VCC02
	Rojo brillante [RAL 3020]	S080-VCC03
	Magenta tele [RAL 4010]	S080-VCC18
	Rosa claro [RAL 3015]	S080-VCC05
	Naranja [RAL 2004]	S080-VCC06
	Amarillo [RAL 1018]	S080-VCC07
	Verde brillante	S080-VCC19
	Azul celeste [RAL 5015]	S080-VCC20
	Azul marino [RAL 5002]	S080-VCC11
	Lila [RAL 4005]	S080-VCC12
	Violeta [RAL 4008]	S080-VCC13
	Aluminio brillante [RAL 9006]	S080-VCC14
	Negro mate [RAL 9005]	S080-VCC15
	Charol negro [RAL 9005]	S080-VCC16
	Gris tráfico brillante [RAL 7043]	S080-VCC17

COLOR 2 (área gris)





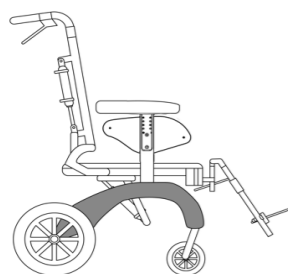

	Blanco [RAL 9016]	S080-VCD01
	Rojo metalizado [RAL 3002]	S080-VCD02
	Rojo brillante [RAL 3020]	S080-VCD03
	Magenta tele [RAL 4010]	S080-VCD18
	Rosa claro [RAL 3015]	S080-VCD05
	Naranja [RAL 2004]	S080-VCD06
	Amarillo [RAL 1018]	S080-VCD07
	Verde brillante	S080-VCD19
	Azul celeste [RAL 5015]	S080-VCD20
	Azul marino [RAL 5002]	S080-VCD11
	Lila [RAL 4005]	S080-VCD12
	Violeta [RAL 4008]	S080-VCD13
	Aluminio brillante [RAL 9006]	S080-VCD14
	Negro mate [RAL 9005]	S080-VCD15
	Charol negro [RAL 9005]	S080-VCD16
	Gris tráfico brillante [RAL 7043]	S080-VCD17

PERSONALIZACIONES

STICKERS PARA CHASIS

Diseños a elegir para personalizar la zona de la silla marcada en gris.







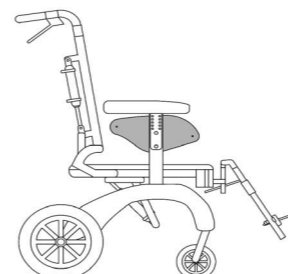

	Autos	<input type="radio"/>	par	61,45 €	S065-V601
	Infantil	<input type="radio"/>	par	61,45 €	S065-V602
	Tattoo	<input type="radio"/>	par	61,45 €	S065-V603
	Flores	<input type="radio"/>	par	61,45 €	S065-V604
	City	<input type="radio"/>	par	61,45 €	S065-V605
	Cashmere	<input type="radio"/>	par	61,45 €	S065-V606
	Sport	<input type="radio"/>	par	61,45 €	S065-V607
	Neutro	<input type="radio"/>	par	61,45 €	S065-V608

STICKERS PARA PROTECTOR LATERAL

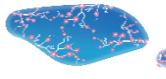
Diseños a elegir para personalizar la zona de la silla marcada en gris.









	Autos	<input type="radio"/>	par	61,45 €	S065-V646
	Infantil	<input type="radio"/>	par	61,45 €	S065-V647
	Tattoo	<input type="radio"/>	par	61,45 €	S065-V648
	Flores	<input type="radio"/>	par	61,45 €	S065-V649
	City	<input type="radio"/>	par	61,45 €	S065-V650
	Cashmere	<input type="radio"/>	par	61,45 €	S065-V651
	Sport	<input type="radio"/>	par	61,45 €	S065-V652
	Neutro	<input type="radio"/>	par	61,45 €	S065-V653

STICKERS PARA MESA

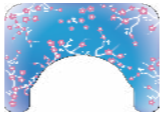
Diseños a elegir para personalizar la zona marcada en gris.

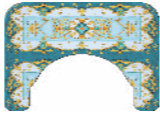

	Autos	<input type="radio"/>	86,00 €	S065-V662
	Infantil	<input type="radio"/>	86,00 €	S065-V663
	Tattoo	<input type="radio"/>	86,00 €	S065-V664
	Flores	<input type="radio"/>	86,00 €	S065-V665
	City	<input type="radio"/>	86,00 €	S065-V666
	Cashmere	<input type="radio"/>	86,00 €	S065-V667
	Sport	<input type="radio"/>	86,00 €	S065-V668
	Neutro	<input type="radio"/>	86,00 €	S065-V669

OBSERVACIONES
